

# **Application Manual**

## **VCXO2E**

### **High Temperature VCXO Clock Oscillator 5 MHz – 40 MHz**

**TABLE OF CONTENTS**

<b>1. OVERVIEW</b> .....	<b>3</b>
<b>1.1. GENERAL DESCRIPTION</b> .....	<b>3</b>
<b>1.2. APPLICATIONS</b> .....	<b>3</b>
<b>1.3. ORDERING INFORMATION</b> .....	<b>4</b>
<b>2. BLOCK DIAGRAM</b> .....	<b>5</b>
<b>2.1. PINOUT</b> .....	<b>5</b>
<b>2.2. PIN DESCRIPTION</b> .....	<b>5</b>
<b>3. ELECTRICAL SPECIFICATIONS</b> .....	<b>6</b>
<b>3.1. ABSOLUTE MAXIMUM RATINGS</b> .....	<b>6</b>
<b>3.2. OPERATING PARAMETERS</b> .....	<b>7</b>
<b>3.3. TYPICAL CHARACTERISTICS</b> .....	<b>7</b>
<b>3.4. OSCILLATOR PARAMETERS</b> .....	<b>8</b>
3.4.1. FREQUENCY VS. TEMPERATURE CHARACTERISTICS .....	<b>8</b>
<b>4. PACKAGE</b> .....	<b>9</b>
<b>4.1. DIMENSIONS AND SOLDER PAD LAYOUT</b> .....	<b>9</b>
4.1.1. PACKAGE WITH CERAMIC LID .....	<b>9</b>
4.1.2. PACKAGE WITH METAL LID (FOR T RANGE VERSION).....	<b>10</b>
<b>4.2. MARKING AND PIN #1 INDEX</b> .....	<b>11</b>
<b>5. MATERIAL COMPOSITION DECLARATION &amp; ENVIRONMENTAL INFORMATION</b> .....	<b>12</b>
<b>5.1. HOMOGENOUS MATERIAL COMPOSITION DECLARATION (CERAMIC LID)</b> .....	<b>12</b>
<b>5.2. RECYCLING MATERIAL INFORMATION (CERAMIC LID)</b> .....	<b>13</b>
<b>5.3. ENVIRONMENTAL PROPERTIES &amp; ABSOLUTE MAXIMUM RATINGS (CERAMIC LID)</b> .....	<b>14</b>
<b>5.4. HOMOGENOUS MATERIAL COMPOSITION DECLARATION (METAL LID)</b> .....	<b>15</b>
<b>5.5. RECYCLING MATERIAL INFORMATION (METAL LID)</b> .....	<b>16</b>
<b>5.6. ENVIRONMENTAL PROPERTIES &amp; ABSOLUTE MAXIMUM RATINGS (METAL LID)</b> .....	<b>17</b>
<b>6. APPLICATION INFORMATION</b> .....	<b>18</b>
<b>6.1. TEST CIRCUIT</b> .....	<b>18</b>
<b>6.2. OUTPUT WAVEFORM</b> .....	<b>19</b>
<b>6.3. SOLDERING INFORMATION</b> .....	<b>20</b>
<b>6.4. HANDLING PRECAUTIONS FOR MODULES WITH EMBEDDED CRYSTALS</b> .....	<b>21</b>
<b>7. COMPLIANCE INFORMATION</b> .....	<b>22</b>
<b>8. DOCUMENT REVISION HISTORY</b> .....	<b>22</b>

## VCXO2E

### High Temperature VCXO Clock Oscillator 5 MHz – 40 MHz

#### 1. OVERVIEW

- Voltage Controlled Oscillator with built-in AT-cut crystal (VCXO), operating in fundamental mode
- Minimum Absolute Pull Range APR for temperature range:
  - $\pm 130$  ppm for B = -40 to +85°C
  - $\pm 110$  ppm for C = -55 to +125°C
  - $\pm 90$  ppm for R = -10 to +150°C
  - $\pm 50$  ppm for S = -10 to +175°C
  - $\pm 30$  ppm for T = -10 to +210°C
- Very fast start-up: typ.1 ms at 25°C
- Output signal HCMOS compatible
- High shock and vibration resistance
- Operating voltage: 3.3 V
- Power consumption:
  - < 4 mA, F  $\leq$  10 MHz
  - < 5 mA, F  $\leq$  20 MHz
  - < 20 mA, F  $\leq$  40 MHz
- Operating temperature range:
  - B = -40 to +85°C
  - C = -55 to +125°C
  - R = -10 to +150°C
  - S = -10 to +175°C
  - T = -10 to +210°C
  - X = Custom
- Low aging rate
- Ceramic SMD package (5.0 x 3.2 mm), RoHS-compliant and 100% lead-free

#### 1.1. GENERAL DESCRIPTION

The VCXO2E combines a High Temperature, Voltage Controlled High Frequency HCMOS oscillator circuitry together with an AT-cut quartz crystal in a hermetically sealed ceramic package with ceramic lid. No external components are required.

The frequency output 5 MHz – 40 MHz on F<sub>OUT</sub> pin is always enabled. The frequency can be adjusted by varying the control voltage applied to the Control Voltage Input pin V<sub>C</sub>.

#### 1.2. APPLICATIONS

The VCXO2E voltage controlled clock oscillator module combines outstanding performance and robustness in a standard ceramic package:

- VCXO oscillator module (embedded XTAL) in a standard 5.0 x 3.2 mm lead-free ceramic package
- Temperature range up to +210°C
- High shock and vibration resistant

The robust construction and high performances make this product perfectly suitable for many high reliability applications:

- Harsh Environment: Geothermal Equipment, Down Hole and Well Drilling
- Avionics / Aerospace: Airborne Equipment / Engine Control / Actuator Controller / Temperature Controller / Instrumentation / Navigation and Guidance Systems
- Instrumentation: Field Test Instrument / Automotive Test Equipment
- Security / Safety: Survival and Protection System / Railway Security System / Fire Fighter Equipment
- Industrial: Telemetry / A/C Controller / Hydraulic Sensor

**1.3. ORDERING INFORMATION**

Example: VCXO2E V – S 20.000 MHz T3 XXX

Code	Package Size
VCXO2E	5.0 x 3.2 mm

Code	Supply voltage
V	$V_{DD} = 3.3\text{ V}$

Code	Temperature range
B	-40 to +85°C
C	-55 to +125°C
R	-10 to +150°C
S	-10 to +175°C
T	-10 to +210°C *
X	Custom

Code	Frequency
20.000 MHz	20.000 MHz

Code	Option 2
T3	SnAgCu solder dipped pads **
Blank	Au flashed pads

Code	Customer specification N°
XXX	XXX

\* Kovar lid on T range version.

\*\* T3 not available for T range version.

## 2. BLOCK DIAGRAM

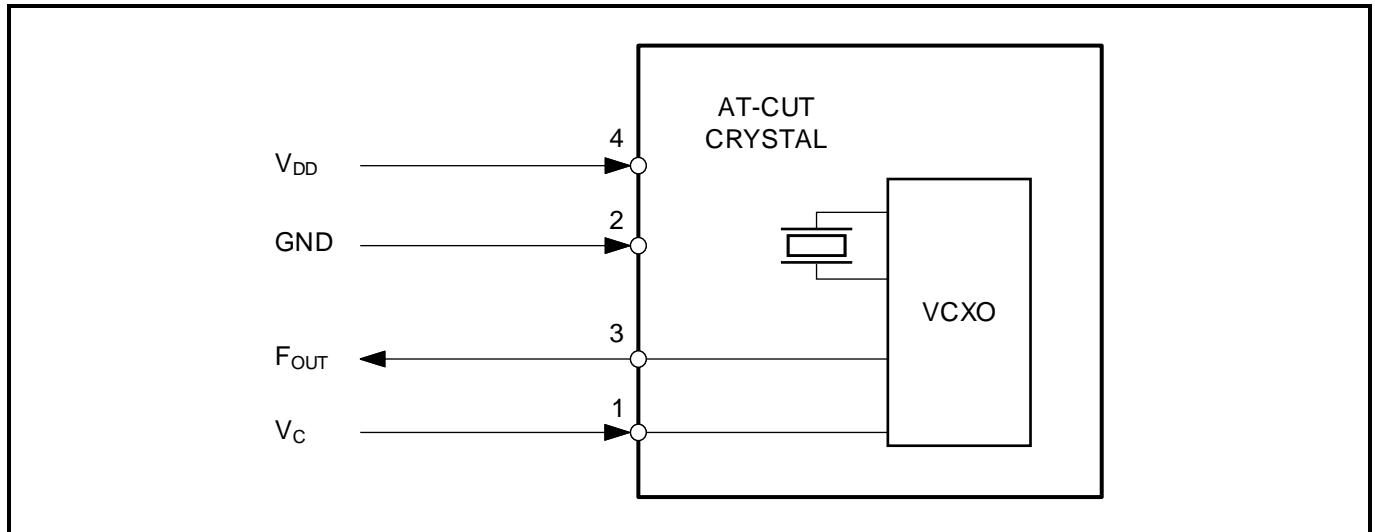

### 2.1. PINOUT

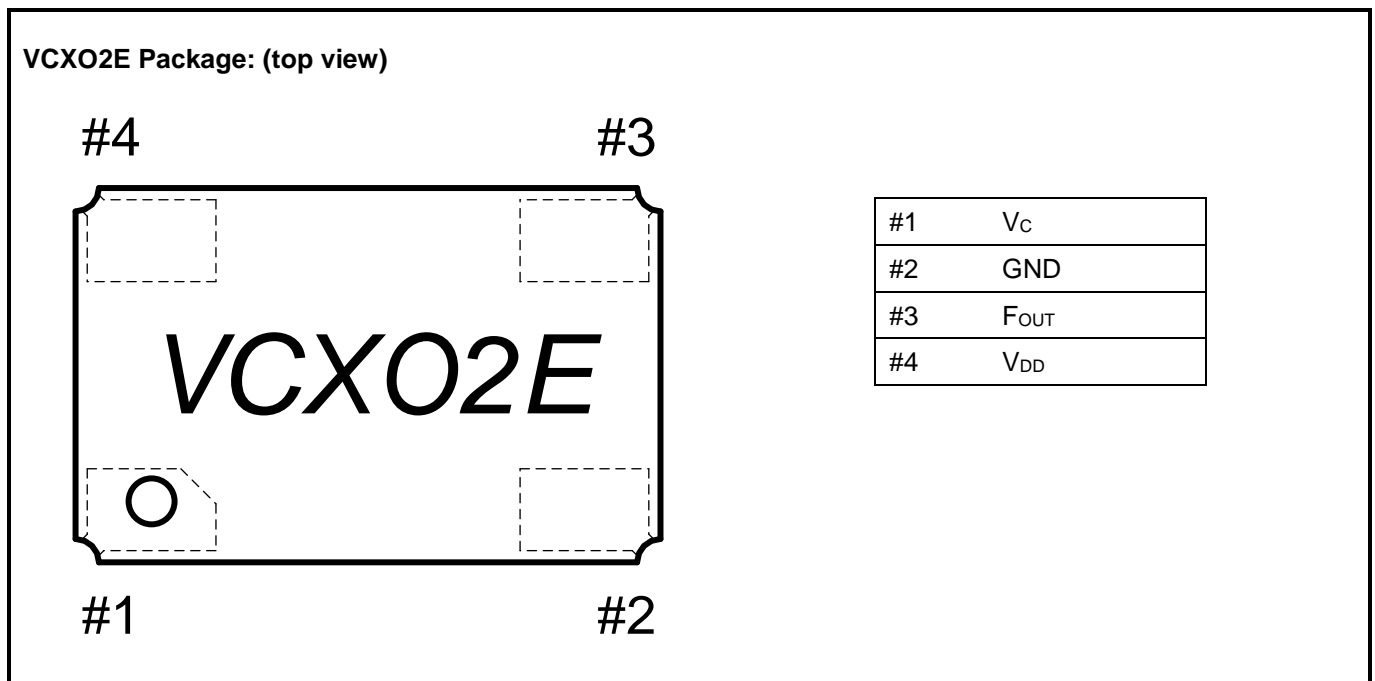

### 2.2. PIN DESCRIPTION

Symbol	Pin #	Description
V <sub>C</sub>	1	Control Voltage Input. The frequency on F <sub>OUT</sub> pin can be adjusted by varying the voltage applied to V <sub>C</sub> . The slope polarity is positive (increasing voltage increases output frequency).
GND	2	Ground.
F <sub>OUT</sub>	3	Clock Output; always enabled. F <sub>OUT</sub> pin drives the square wave of the frequency. The frequency can be adjusted by varying the control voltage applied to the V <sub>C</sub> pin.
V <sub>DD</sub>	4	Power Supply Voltage.

### 3. ELECTRICAL SPECIFICATIONS

#### 3.1. ABSOLUTE MAXIMUM RATINGS

Absolute Maximum Ratings according to IEC 60134:

SYMBOL	PARAMETER	CONDITIONS	MIN	MAX	UNIT
V <sub>DD</sub>	Power supply voltage	Nominal V <sub>DD</sub> = 3.3 V	-0.3	3.8	V
V <sub>I</sub>	Input voltage		-0.3	V <sub>DD</sub>	V
V <sub>O</sub>	Output voltage		-0.3	V <sub>DD</sub>	V
V <sub>ESD</sub>	ESD voltage	HBM (1)		±2000	V
		MM (2)		±200	
T <sub>B</sub>	Operating temperature range B		-40	85	°C
T <sub>C</sub>	Operating temperature range C		-55	125	°C
T <sub>R</sub>	Operating temperature range R		-10	150	°C
T <sub>S</sub>	Operating temperature range S		-10	175	°C
T <sub>T</sub>	Operating temperature range T		-10	210	°C
T <sub>STO</sub>	Storage temperature	Stored as bare product	-65	125	°C
T <sub>PEAK</sub>	Maximum reflow condition	JEDEC J-STD-020C		265	°C

(1) HBM: Human Body Model, according to JESD22-A114.

(2) MM: Machine Model, according to JESD22-A115.

### 3.2. OPERATING PARAMETERS

For this Table,  $V_{DD}$  = nominal voltage;  $GND = 0\text{ V}$ ;  $T_A = 25\text{ °C}$ ; unless otherwise indicated.

Operating Parameters:

SYMBOL	PARAMETER	CONDITIONS	MIN	TYP	MAX	UNIT
<b>Supply</b>						
$V_{DD}$	Power supply voltage <sup>(1)</sup>	Nominal $V_{DD} = 3.3\text{ V}$	3.135		3.465	V
$I_{DD}$	Input current. $V_{DD} = 3.3\text{ V}$ , no load	$5\text{ MHz} \leq F \leq 10\text{ MHz}$			4	mA
		$10\text{ MHz} < F \leq 20\text{ MHz}$			5	
		$20\text{ MHz} < F \leq 40\text{ MHz}$			20	
<b>Input <math>V_C</math></b>						
$V_C$	Control voltage range		0		3.3	V
	Slope polarity		positive			
$V_{CBW}$	Control voltage bandwidth	@ -3 dB	10			kHz
$Z_{VC}$	$V_C$ input impedance		100			k $\Omega$
<b>Output <math>F_{OUT}</math> (HCMOS compatible)</b>						
$V_{OH}$	HIGH level output voltage		$V_{DD} - 0.5$			V
$V_{OL}$	LOW level output voltage				0.4	V
$C_L$	Output load capacitance	HCMOS	3	15	47	pF
$t_r / t_f$	Rise & fall time	$C_L = 15\text{ pF}$ , 20% to 80% $V_{DD}$			5	ns

(1) A 47 nF decoupling capacitor has to be connected between  $V_{DD}$  and GND.

### 3.3. TYPICAL CHARACTERISTICS

Supply current  $I_{DD}$  vs. Frequency  $F$ :  $T_A = 25\text{ °C}$ ,  $V_{DD} = 3.3\text{ V}$ , no load

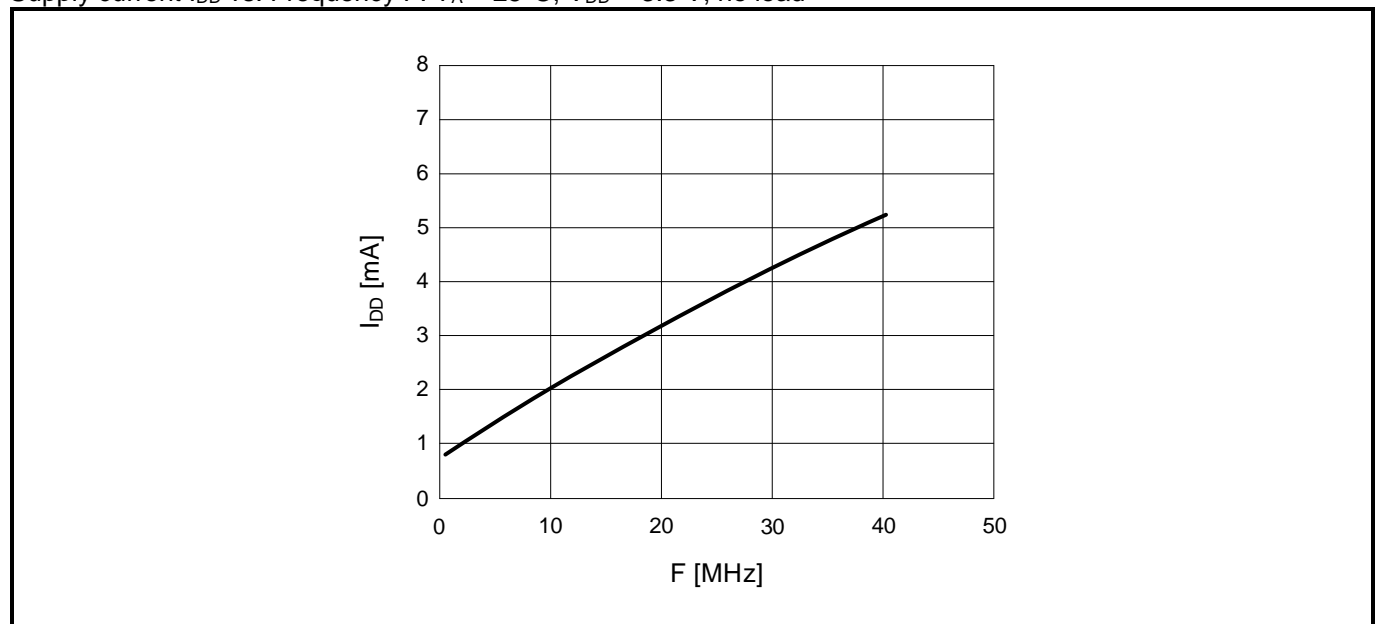

### 3.4. OSCILLATOR PARAMETERS

For this Table,  $V_{DD}$  = nominal voltage; GND = 0 V;  $T_A$  = 25 °C; unless otherwise indicated.

Oscillator Parameters:

SYMBOL	PARAMETER	CONDITIONS	MIN	TYP	MAX	UNIT
<b>General</b>						
F	Frequency range		5		40	MHz
$t_{START}$	Oscillator start-up time			1	5	ms
$\delta_{FOUT}$	$F_{OUT}$ duty cycle @ $V_{DD}/2$		40		60	%
<b>Frequency Performance</b>						
$\Delta F/F$	<b>Minimum Absolute Pull Range APR</b> (see ORDERING INFORMATION)	Including adjustment at +25°C, long term aging 1 year, $V_{DD}$ variations $\pm 5\%$ , $C_L$ variations min. to max. and frequency stability over temperature range. For temperature range B = -40 to +85°C C = -55 to +125°C R = -10 to +150°C S = -10 to +175°C T = -10 to +210°C	$\pm 130$ $\pm 110$ $\pm 90$ $\pm 50$ $\pm 30$			ppm

#### 3.4.1.FREQUENCY VS. TEMPERATURE CHARACTERISTICS

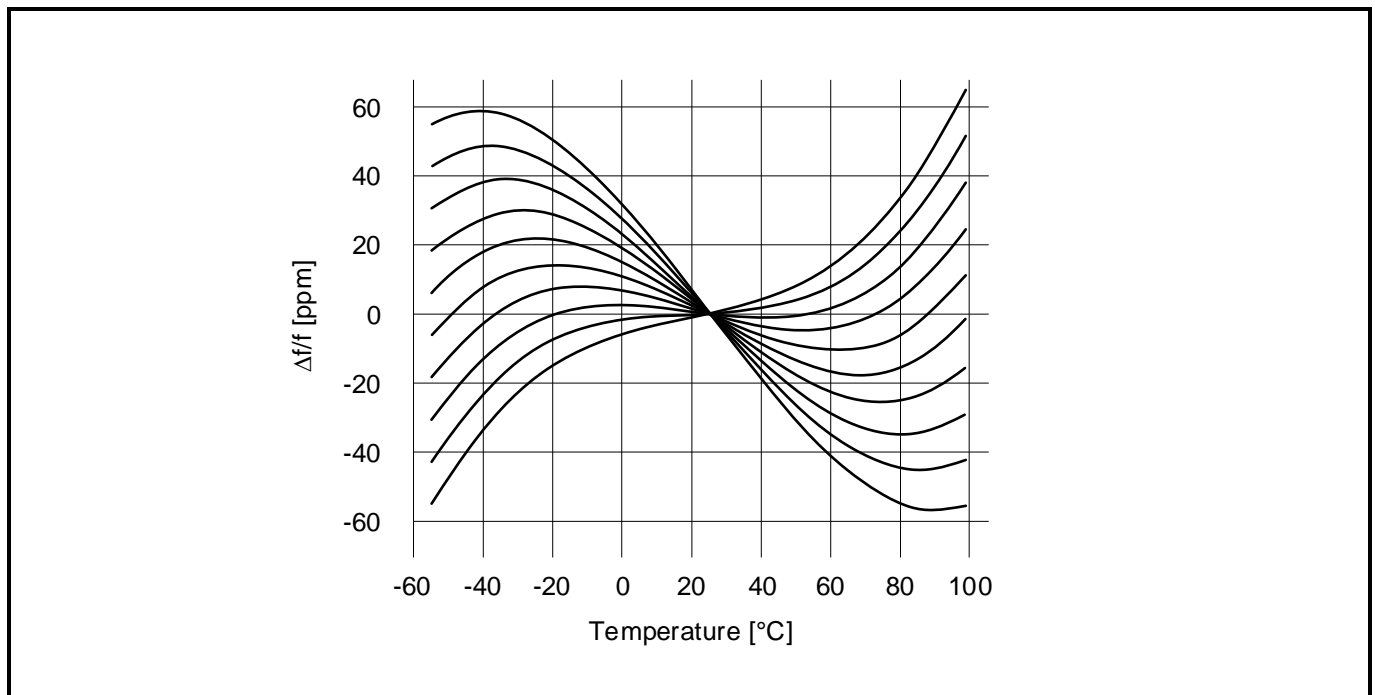



### 4. PACKAGE

#### 4.1. DIMENSIONS AND SOLDER PAD LAYOUT

##### 4.1.1. PACKAGE WITH CERAMIC LID

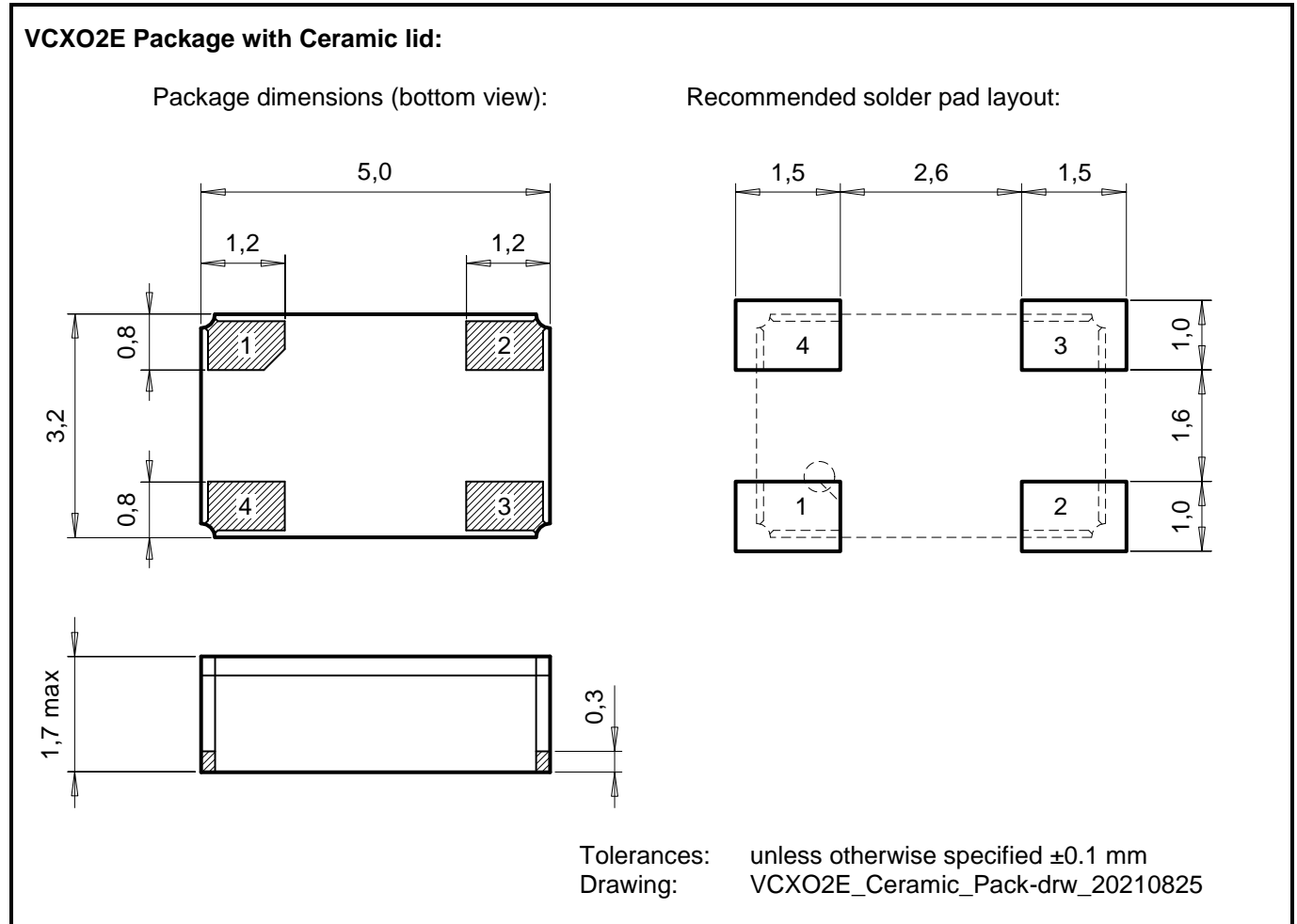

All dimensions in mm typical.

4.1.2. PACKAGE WITH METAL LID (FOR T RANGE VERSION)

VCXO2E Package with Metal lid (for T range version):

Package dimensions (bottom view):

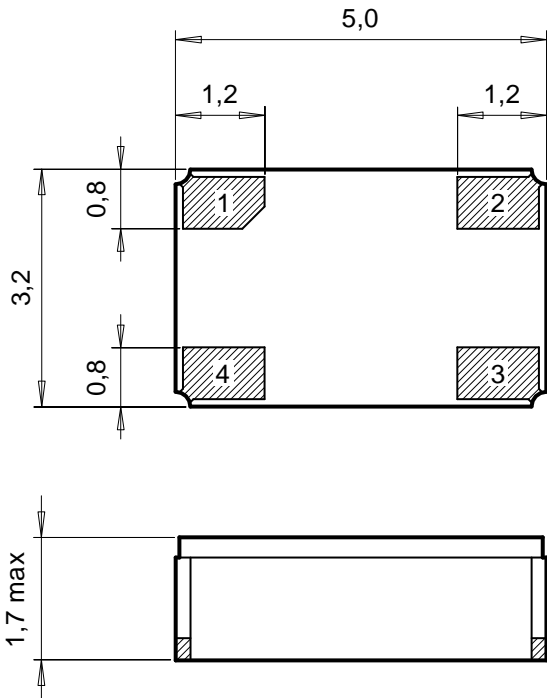

Recommended solder pad layout:

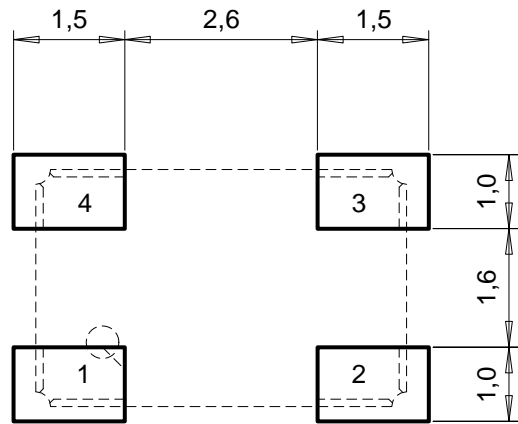

Tolerances: unless otherwise specified  $\pm 0.1$  mm  
 Drawing: VCXO2E\_Metal\_Pack-drw\_20210825

All dimensions in mm typical.

4.2. MARKING AND PIN #1 INDEX

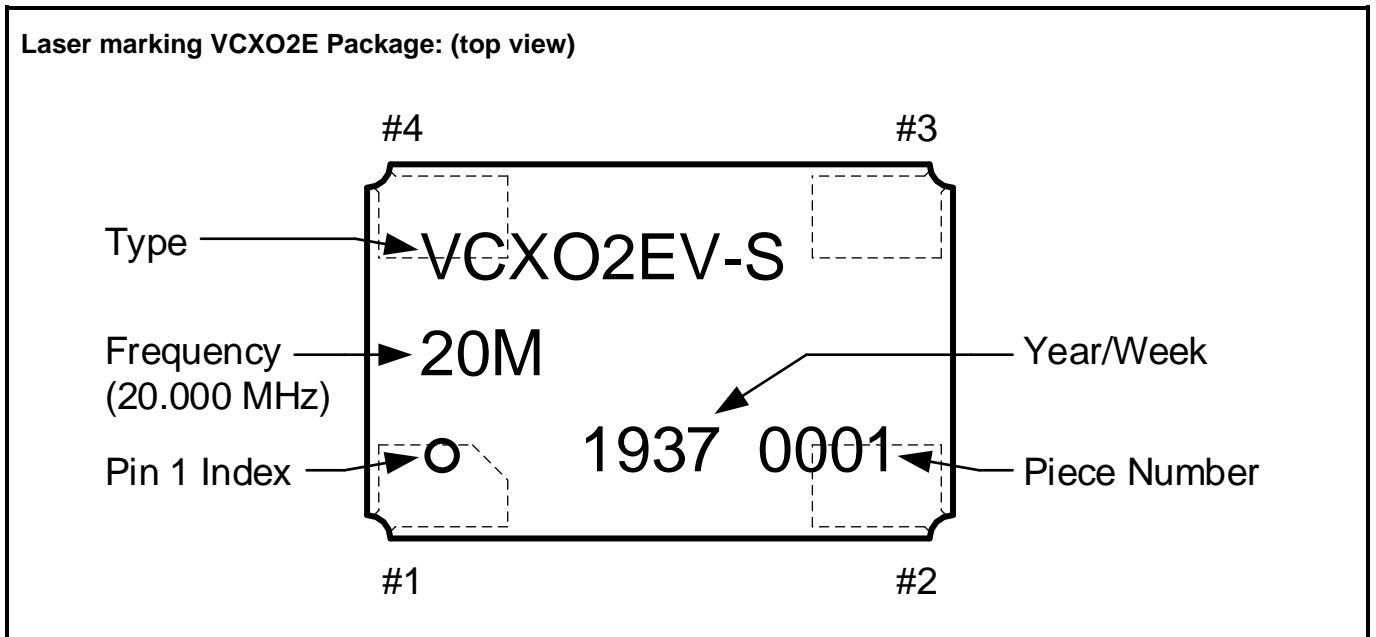

**5. MATERIAL COMPOSITION DECLARATION & ENVIRONMENTAL INFORMATION**

**5.1. HOMOGENOUS MATERIAL COMPOSITION DECLARATION (CERAMIC LID)**

Homogenous material information according to IPC-1752 standard

Material Composition VCXO2E (Ceramic lid):

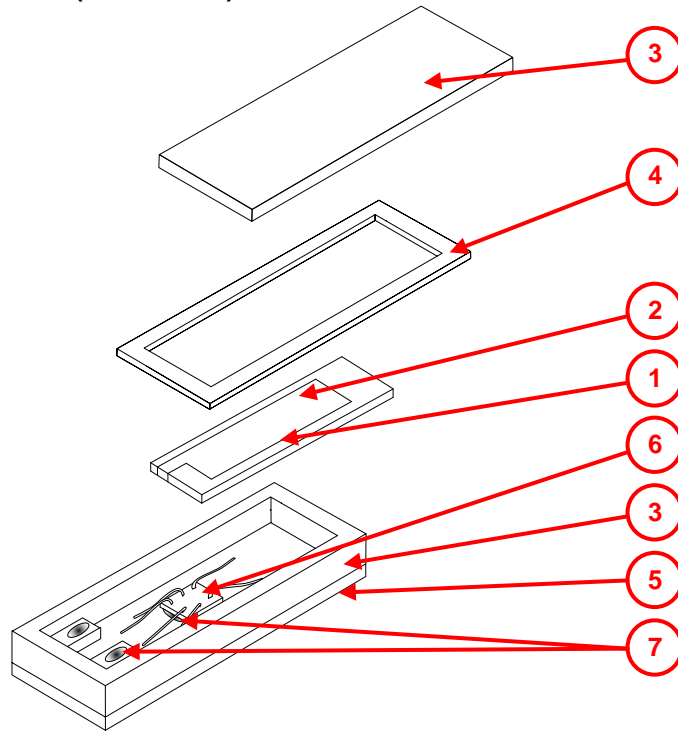

(Symbolic drawing)



No.	Item Component Name	Sub Item Material Name	Material Weight		Substance Element	CAS Number	Comment
			(mg)	(%)			
1	Resonator	Quartz Crystal	3.7	100%	SiO <sub>2</sub>	14808-60-7	
2	Electrodes	Cr+Au	0.2	5%	Cr	Cr: 7440-47-3	
				95%	Au	Au: 7440-57-5	
3	Housing	Ceramic	63.1	100%	Al <sub>2</sub> O <sub>3</sub>	1344-28-1	
4	Seal	Solder Preform	3.6	80%	Au80 / Sn20	Au: 7440-57-5	
				20%		Sn: 7440-31-5	
5	Terminations	Internal and external terminals	5.1	80%	W	W: 7440-33-7	Tungsten
				15%	Ni	Ni: 7440-02-0	Nickel plating
				5%	Au 0.3 micron	Au: 7440-57-5	Gold plating
6	HCMOS IC	Silicon	1.0	95%	Si	Si: 7440-21-3	
		Die pad plating		1%	Al	Al: 7429-90-5	
		Bonding wires		4%	Al	Al: 7429-90-5	
7	Conductive adhesive	Silver filled Epoxy	1.3	70%	Ag	Ag: 7440-22-4	
				30%	EP	129915-35-1	
		Unit weight typ. ±10%	78				

**5.2. RECYCLING MATERIAL INFORMATION (CERAMIC LID)**

Recycling material information according to IPC-1752 standard.

Element weight is accumulated and referenced to the unit weight of 78 mg.

Item Material Name	No.	Item Component Name	Material Weight		Substance Element	CAS Number	Comment
			(mg)	(%)			
Quartz Crystal	1	Resonator	3.7	4.74	SiO <sub>2</sub>	14808-60-7	
Chromium	2	Electrodes	0.01	0.013	Cr	Cr: 7440-47-3	
Ceramic	3	Housing	63.1	80.9	Al <sub>2</sub> O <sub>3</sub>	1344-28-1	
Gold	2	Electrodes	3.32	4.26	Au	Au: 7440-57-5	
	4	Seal					
	5	Terminations					
Tin	4	Seal	0.72	0.92	Sn	Sn: 7440-31-5	
Nickel	5	Terminations	0.77	0.98	Ni	Ni: 7440-02-0	
Tungsten	5	Terminations	4.08	5.23	W	W: 7440-33-7	
Silicon	6a	HCMOS IC	0.95	1.22	Si	Si: 7440-21-3	
Aluminum	6b	HCMOS IC	0.05	0.06	Al	Al: 7429-90-5	
	6c	HCMOS IC					
Silver	7a	Conductive adhesive	0.91	1.17	Ag	Ag: 7440-22-4	
Epoxy	7b	Conductive adhesive	0.39	0.50	EP	129915-35-1	
Unit weight (total) typ. ±10%			78	100			

**5.3. ENVIRONMENTAL PROPERTIES & ABSOLUTE MAXIMUM RATINGS (CERAMIC LID)**

Package	Description
DFN-4 ceramic package	Dual Flat No Leads (DFN), hermetically sealed ceramic package with ceramic lid.

Parameter	Directive	Conditions	Value
Product weight (total)			78 mg
Storage temperature		Store as bare product	-65 to +125°C
Moisture sensitivity level (MSL)	IPC/JEDEC J-STD-020D		MSL1
MTTF			> 100 years

Terminal finish:

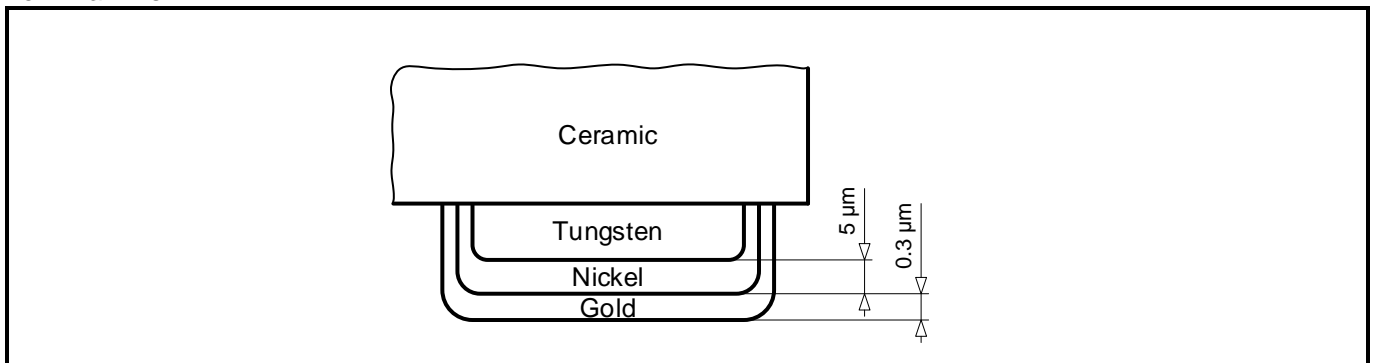

**5.4. HOMOGENOUS MATERIAL COMPOSITION DECLARATION (METAL LID)**

Homogenous material information according to IPC-1752 standard

**Material Composition VCXO2E (Metal lid):**

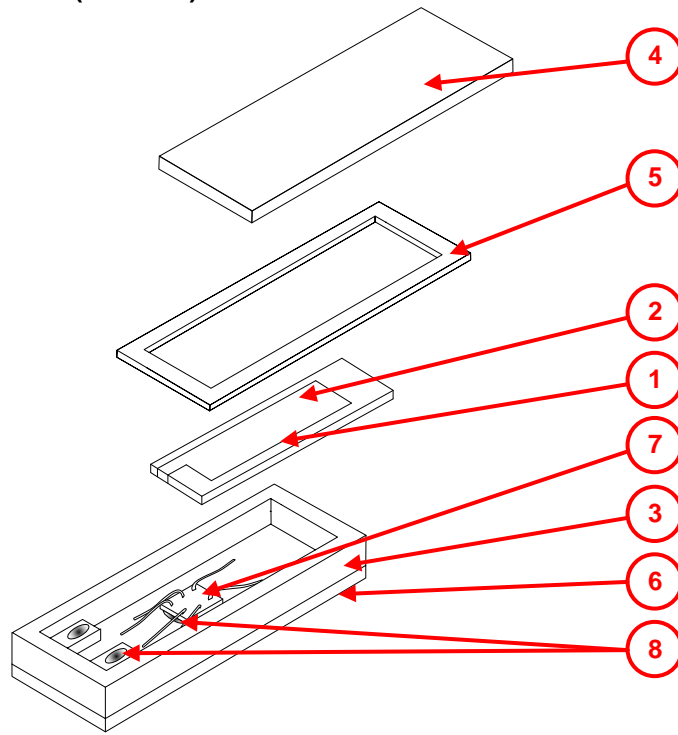

(Symbolic drawing)



No.	Item Component Name	Sub Item Material Name	Material Weight		Substance Element	CAS Number	Comment
			(mg)	(%)			
1	Resonator	Quartz Crystal	3.7	100%	SiO <sub>2</sub>	14808-60-7	
2	Electrodes	Cr+Au	0.2	5%	Cr	Cr: 7440-47-3	
				95%	Au	Au: 7440-57-5	
3	Housing	Ceramic	48.7	100%	Al <sub>2</sub> O <sub>3</sub>	1344-28-1	
4	Metal Lid	Kovar Lid	32.0	90%	Fe53Ni29Co18	Fe: 7439-89-6	
						Ni: 7440-02-0	
						Co: 7440-48-4	
						Ni: 7440-02-0	Nickel plating
		Ni-plating		9%	Ni	Ni: 7440-02-0	
		Au-plating		1%	Au	Au: 7440-57-5	Gold plating
5	Seal	Solder Preform	3.6	80%	Au80 / Sn20	Au: 7440-57-5	
			20%	Sn: 7440-31-5			
6	Terminations	Internal and external terminals	3.5	80%	W	W: 7440-33-7	Tungsten
				15%	Ni	Ni: 7440-02-0	Nickel plating
				5%	Au 0.3 micron	Au: 7440-57-5	Gold plating
7	HCMOS IC	Silicon	1.0	95%	Si	Si: 7440-21-3	
				1%	Al	Al: 7429-90-5	
				4%	Al	Al: 7429-90-5	
8	Conductive adhesive	Silver filled Epoxy	1.3	70%	Ag	Ag: 7440-22-4	
				30%	EP	129915-35-1	
		Unit weight typ. ±10%	94				

**5.5. RECYCLING MATERIAL INFORMATION (METAL LID)**

Recycling material information according to IPC-1752 standard.

Element weight is accumulated and referenced to the unit weight of 94 mg.

Item Material Name	No.	Item Component Name	Material Weight		Substance Element	CAS Number	Comment
			(mg)	(%)			
Quartz Crystal	1	Resonator	3.7	3.94	SiO <sub>2</sub>	14808-60-7	
Chromium	2	Electrodes	0.01	0.011	Cr	Cr: 7440-47-3	
Ceramic	3	Housing	48.7	51.8	Al <sub>2</sub> O <sub>3</sub>	1344-28-1	
Gold	2	Electrodes	3.56	3.79	Au	Au: 7440-57-5	
	4	Metal Lid					
	5	Seal					
	6	Terminations					
Tin	5	Seal	0.72	0.77	Sn	Sn: 7440-31-5	
Nickel	4	Metal Lid (Plating)	3.41	3.62	Ni	Ni: 7440-02-0	
	6	Terminations					
Tungsten	6	Terminations	2.80	2.98	W	W: 7440-33-7	
Kovar	4	Metal Lid	28.8	30.6	Fe53Ni29Co18	Fe: 7439-89-6	
						Ni: 7440-02-0	
						Co: 7440-48-4	
Silicon	7a	HCMOS IC	0.95	1.01	Si	Si: 7440-21-3	
Aluminum	7b	HCMOS IC	0.05	0.05	Al	Al: 7429-90-5	
	7c	HCMOS IC					
Silver	8a	Conductive adhesive	0.91	0.97	Ag	Ag: 7440-22-4	
Epoxy	8b	Conductive adhesive	0.39	0.41	EP	129915-35-1	
Unit weight (total) typ. ±10%			94	100			



**5.6. ENVIRONMENTAL PROPERTIES & ABSOLUTE MAXIMUM RATINGS (METAL LID)**

Package	Description
DFN-4 ceramic package	Dual Flat No Leads (DFN), hermetically sealed ceramic package with metal lid.

Parameter	Directive	Conditions	Value
Product weight (total)			94 mg
Storage temperature		Store as bare product	-65 to +125°C
Moisture sensitivity level (MSL)	IPC/JEDEC J-STD-020D		MSL1
MTTF			> 100 years

Terminal finish:

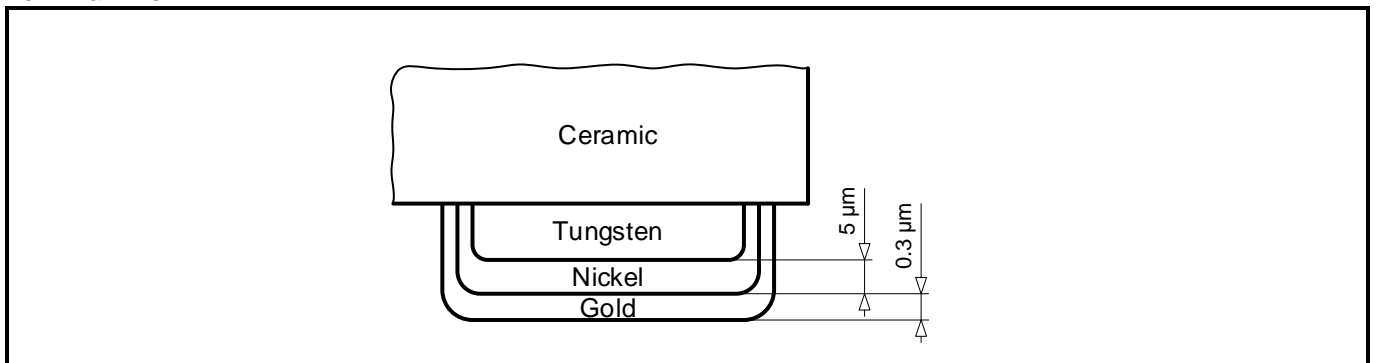

## 6. APPLICATION INFORMATION

### 6.1. TEST CIRCUIT

Test circuit HCMOS:

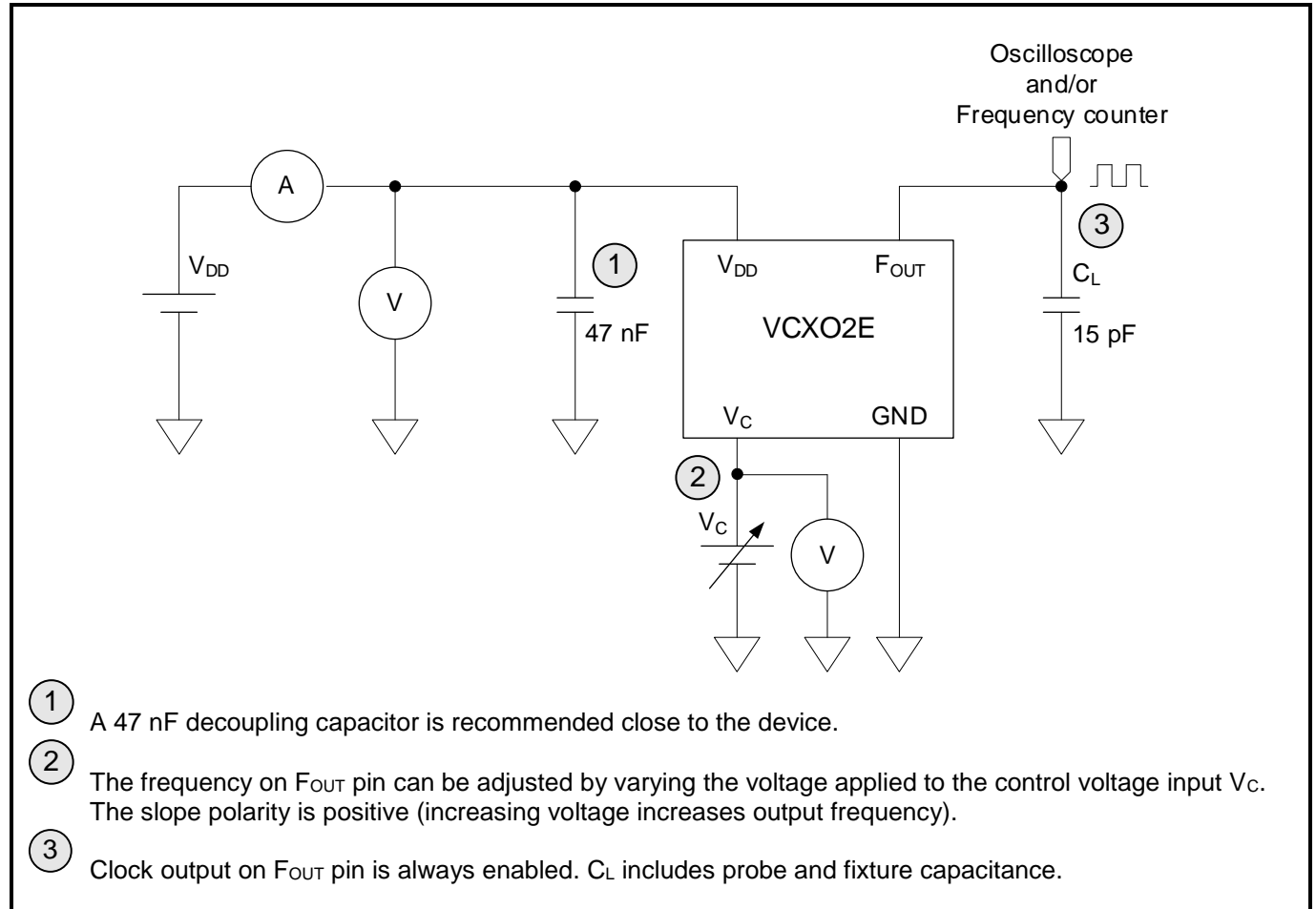

## 6.2. OUTPUT WAVEFORM

Output waveform HCMOS:

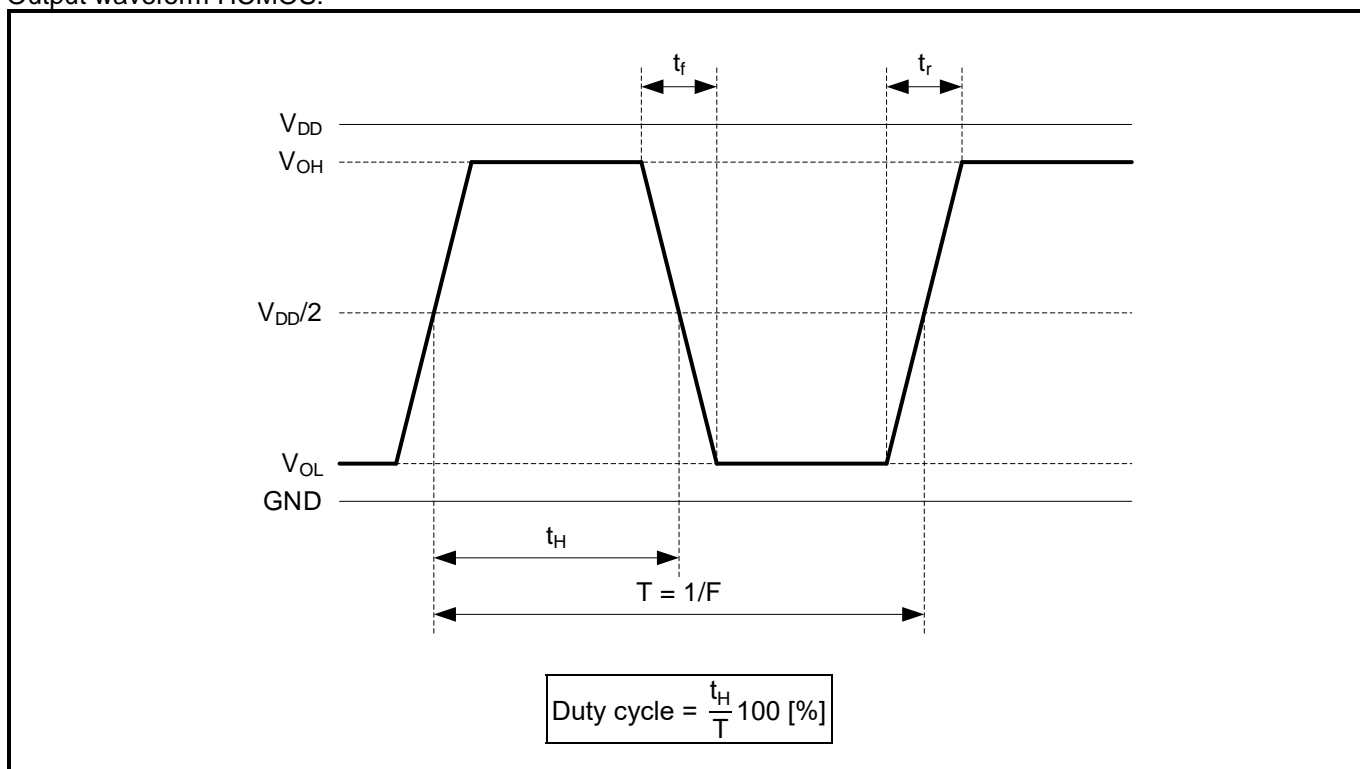

6.3. SOLDERING INFORMATION

Maximum Reflow Conditions in accordance with IPC/JEDEC J-STD-020C “Pb-free”

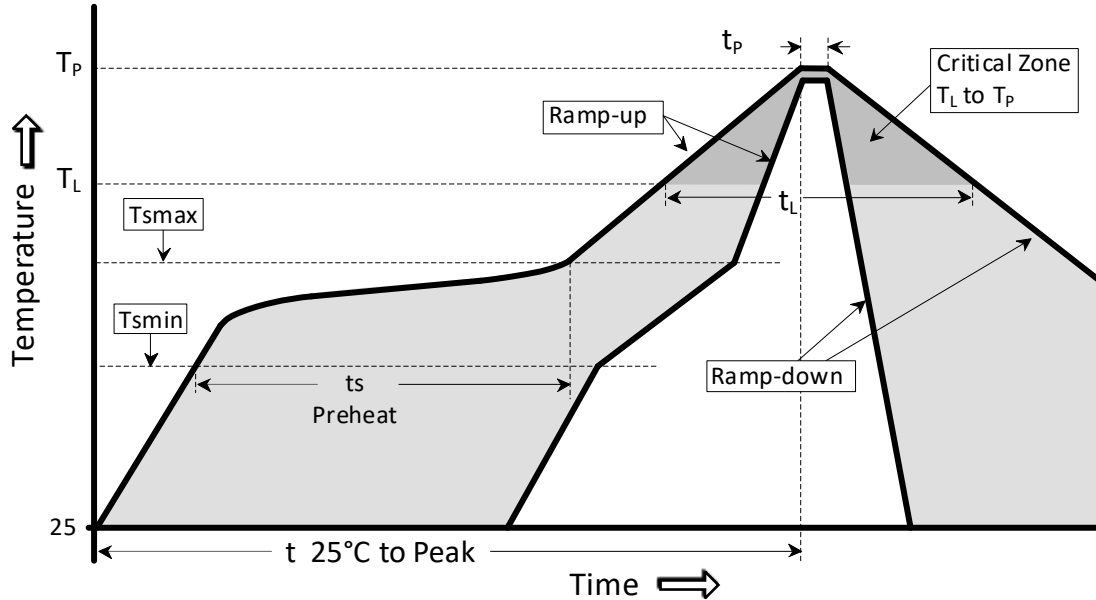

Temperature Profile	Symbol	Condition	Unit
Average ramp-up rate	( $T_{Smax}$ to $T_P$ )	3°C / second max	°C / s
Ramp down Rate	$T_{cool}$	6°C / second max	°C / s
Time 25°C to Peak Temperature	$T_{to-peak}$	8 minutes max	min
<b>Preheat</b>			
Temperature min	$T_{Smin}$	150	°C
Temperature max	$T_{Smax}$	200	°C
Time $T_{Smin}$ to $T_{Smax}$	$t_s$	60 – 180	sec
<b>Soldering above liquidus</b>			
Temperature liquidus	$T_L$	217	°C
Time above liquidus	$t_L$	60 – 150	sec
<b>Peak temperature</b>			
Peak Temperature	$T_p$	260	°C
Time within 5°C of peak temperature	$t_p$	20 – 40	sec

#### 6.4. HANDLING PRECAUTIONS FOR MODULES WITH EMBEDDED CRYSTALS

The built-in AT-cut crystal consists of pure Silicon Dioxide in crystalline form. The cavity inside the package is evacuated and hermetically sealed in order for the crystal blank to function undisturbed from air molecules, humidity and other influences.

##### **Shock and vibration:**

Keep the crystal / module from being exposed to **excessive mechanical shock and vibration**. Micro Crystal guarantees that the crystal / module will bear a mechanical shock of 10000 g / 0.3 ms.

The following special situations may generate either shock or vibration:

**Multiple PCB panels** - Usually at the end of the pick & place process the single PCBs are cut out with a router. These machines sometimes generate vibrations on the PCB that have a fundamental or harmonic frequency close to the resonance frequency of the crystal unit. This might cause breakage of crystal blanks due to resonance. Router speed should be adjusted to avoid resonant vibration.

**Ultrasonic cleaning** - Avoid cleaning processes using ultrasonic energy. These processes can damage the crystals due to the mechanical resonance frequencies of the crystal blank.

##### **Overheating, rework high temperature exposure:**

Avoid overheating the package. The package is sealed with a seal ring consisting of 80% Gold and 20% Tin. The eutectic melting temperature of this alloy is at 280°C. Heating the seal ring up to >280°C will cause melting of the metal seal which then, due to the vacuum, is sucked into the cavity forming an air duct. This happens when using hot-air-gun set at temperatures >280°C.

Use the following methods for rework:

- Use a hot-air-gun set at 270°C.
- Use 2 temperature controlled soldering irons, set at 270°C, with special-tips to contact all solder-joints from both sides of the package at the same time, remove part with tweezers when pad solder is liquid.

## 7. COMPLIANCE INFORMATION

Micro Crystal confirms that the standard product VCXO Clock Oscillator VCXO2E is compliant with “EU RoHS Directive” and “EU REACH Directives”.

Please find the actual Certificate of Conformance for Environmental Regulations on our website:

[CoC Environment MCSO-Series.pdf](#) (contains VCXO2)

## 8. DOCUMENT REVISION HISTORY

Date	Revision #	Revision Details
February 2015	2.0	Initial version
August 2021	3.0	New extended version

The information contained in this document is believed to be accurate and reliable. However, Micro Crystal assumes no responsibility for any consequences resulting from the use of such information nor for any infringement of patents or other rights of third parties, which may result from its use. In accordance with our policy of continuous development and improvement, Micro Crystal reserves the right to modify specifications mentioned in this publication without prior notice and as deemed necessary.

Any use of Products for the manufacture of arms is prohibited. Customer shall impose that same obligation upon all third-party purchasers.

Without the express written approval of Micro Crystal, Products are not authorized for use as components in safety and life supporting systems as well as in any implantable medical devices. The unauthorized use of Products in such systems / applications / equipment is solely at the risk of the customer and such customer agrees to defend and hold Micro Crystal harmless from and against any and all claims, suits, damages, cost, and expenses resulting from any unauthorized use of Products.

No licenses to patents or other intellectual property rights of Micro Crystal are granted in connection with the sale of Micro Crystal products, neither expressly nor implicitly. In respect of the intended use of Micro Crystal products by customer, customer is solely responsible for observing existing patents and other intellectual property rights of third parties and for obtaining, as the case may be, the necessary licenses.



A COMPANY OF THE  SWATCH GROUP

Micro Crystal AG  
Muehlestrasse 14  
CH-2540 Grenchen  
Switzerland

Phone +41 32 655 82 82  
sales@microcrystal.com  
www.microcrystal.com